

KSA709

High Voltage Amplifier

- Collector-Base Voltage : $V_{CBO} = -160V$
- Collector Power Dissipation : $P_C = 800mW$
- Complement to KSC1009
- Suffix "-C" means Center Collector (1. Emitter 2. Collector 3. Base)

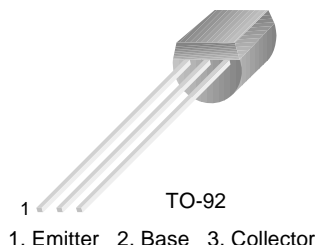

PNP Epitaxial Silicon Transistor

Absolute Maximum Ratings $T_a = 25^\circ C$ unless otherwise noted

Symbol	Parameter	Ratings	Units
V_{CBO}	Collector-Base Voltage	-160	V
V_{CEO}	Collector-Emitter Voltage	-150	V
V_{EBO}	Emitter-Base Voltage	-8	V
I_C	Collector Current	-700	mA
P_C	Collector Power Dissipation	800	mW
T_J	Junction Temperature	150	$^\circ C$
T_{STG}	Storage Temperature	-55 ~ 150	$^\circ C$

Electrical Characteristics $T_a = 25^\circ C$ unless otherwise noted

Symbol	Parameter	Test Condition	Min.	Typ.	Max.	Units
BV_{CBO}	Collector-Base Breakdown Voltage	$I_C = -100\mu A, I_E = 0$	-160			V
BV_{CEO}	Collector-Emitter Breakdown Voltage	$I_C = -10mA, I_B = 0$	-150			V
BV_{EBO}	Emitter-Base Breakdown Voltage	$I_E = -100\mu A, I_C = 0$	-8			V
I_{CBO}	Collector Cut-off Current	$V_{CB} = -100V, I_E = 0$			-0.1	μA
I_{EBO}	Emitter Cut-off Current	$V_{EB} = -5V, I_C = 0$			-0.1	μA
h_{FE}	* DC Current Gain	$V_{CE} = -2V, I_C = -50mA$	70		400	
$V_{CE} (sat)$	* Collector-Emitter Saturation Voltage	$I_C = -200mA, I_B = -20mA$		-0.3	-0.4	V
$V_{BE} (sat)$	* Base-Emitter Saturation Voltage	$I_C = -200mA, I_B = -20mA$		-0.9	-1.0	V
f_T	Current Gain Bandwidth Product	$V_{CE} = -10V, I_C = -50mA$		50		MHz
C_{ob}	Output Capacitance	$V_{CB} = -10V, I_E = 0, f = 1MHz$			10	pF

* Pulse Test: $PW \leq 350\mu s$, Duty cycle $\leq 2\%$

h_{FE} Classification

Classification	O	Y	G
h_{FE}	70 ~ 140	120 ~ 240	200 ~ 400

Typical Characteristics

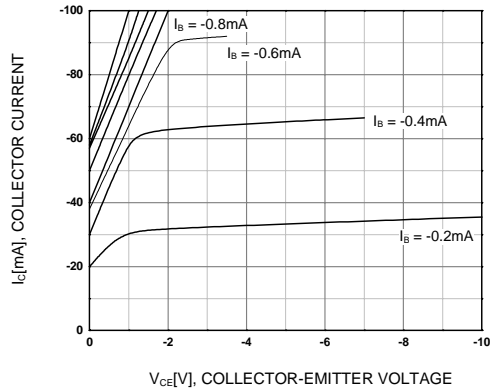

Figure 1. Static Characteristic

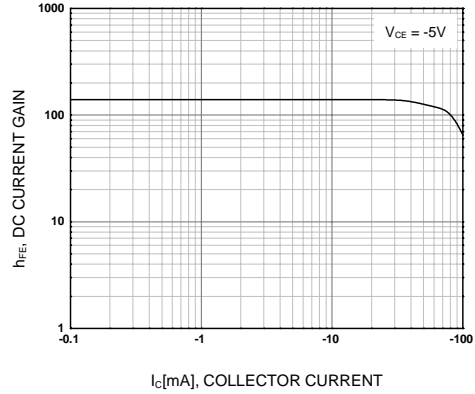

Figure 2. DC current Gain

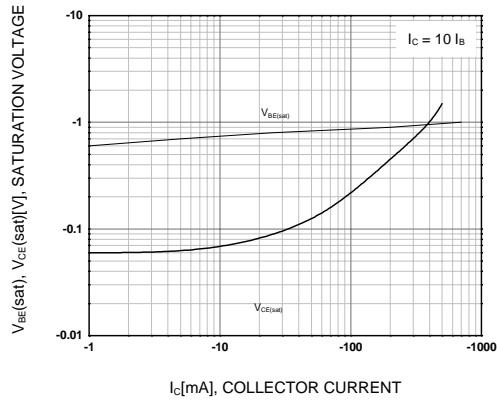

Figure 3. Base-Emitter Saturation Voltage
Collector-Emitter Saturation Voltage

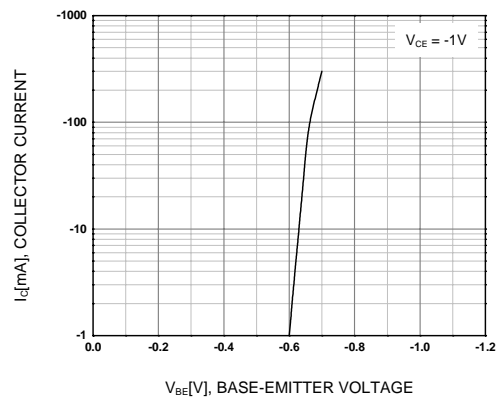

Figure 4. Base-Emitter On Voltage

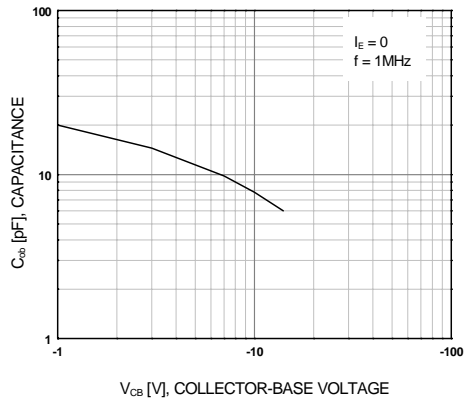
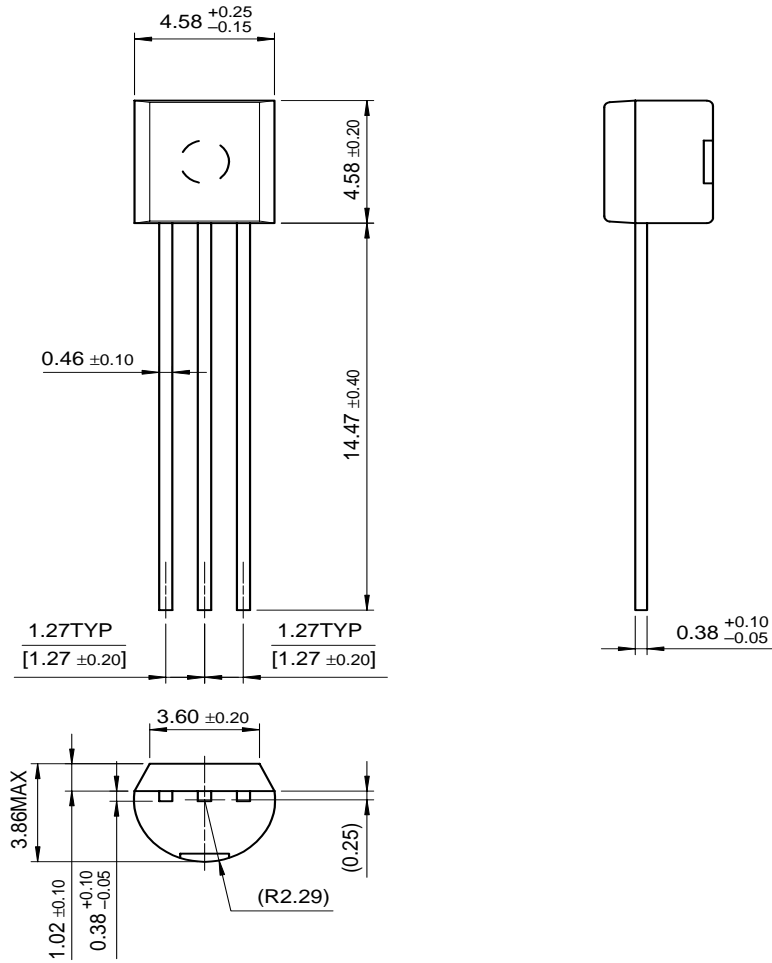

Figure 5. Collector Output Capacitance

Package Dimensions

KSA709

TO-92



Dimensions in Millimeters

TRADEMARKS

The following are registered and unregistered trademarks Fairchild Semiconductor owns or is authorized to use and is not intended to be an exhaustive list of all such trademarks.

ACE [™]	FACT Quiet Series [™]	ImpliedDisconnect [™]	PACMAN [™]	SPM [™]
ActiveArray [™]	FAST [®]	ISOPLANAR [™]	POP [™]	Stealth [™]
Bottomless [™]	FASTr [™]	LittleFET [™]	Power247 [™]	SuperFET [™]
CoolFET [™]	FPST [™]	MICROCOUPLER [™]	PowerSaver [™]	SuperSOT [™] -3
CROSSVOLT [™]	FRFET [™]	MicroFET [™]	PowerTrench [®]	SuperSOT [™] -6
DOMET [™]	GlobalOptoisolator [™]	MicroPak [™]	QFET [®]	SuperSOT [™] -8
EcoSPARK [™]	GTO [™]	MICROWIRE [™]	QS [™]	SyncFET [™]
E ² CMOS [™]	HiSeC [™]	MSX [™]	QT Optoelectronics [™]	TinyLogic [®]
EnSigna [™]	I ² C [™]	MSXPro [™]	Quiet Series [™]	TINYOPTO [™]
FACT [™]	<i>i-Lo</i> [™]	OCX [™]	RapidConfigure [™]	TruTranslation [™]
Across the board. Around the world. [™]		OCXPro [™]	RapidConnect [™]	UHC [™]
The Power Franchise [®]		OPTOLOGIC [®]	SILENT SWITCHER [®]	UltraFET [®]
Programmable Active Droop [™]		OPTOPLANAR [™]	SMART START [™]	VCX [™]

DISCLAIMER

FAIRCHILD SEMICONDUCTOR RESERVES THE RIGHT TO MAKE CHANGES WITHOUT FURTHER NOTICE TO ANY PRODUCTS HEREIN TO IMPROVE RELIABILITY, FUNCTION OR DESIGN. FAIRCHILD DOES NOT ASSUME ANY LIABILITY ARISING OUT OF THE APPLICATION OR USE OF ANY PRODUCT OR CIRCUIT DESCRIBED HEREIN; NEITHER DOES IT CONVEY ANY LICENSE UNDER ITS PATENT RIGHTS, NOR THE RIGHTS OF OTHERS.

LIFE SUPPORT POLICY

FAIRCHILD'S PRODUCTS ARE NOT AUTHORIZED FOR USE AS CRITICAL COMPONENTS IN LIFE SUPPORT DEVICES OR SYSTEMS WITHOUT THE EXPRESS WRITTEN APPROVAL OF FAIRCHILD SEMICONDUCTOR CORPORATION.

As used herein:

1. Life support devices or systems are devices or systems which, (a) are intended for surgical implant into the body, or (b) support or sustain life, or (c) whose failure to perform when properly used in accordance with instructions for use provided in the labeling, can be reasonably expected to result in significant injury to the user.
2. A critical component is any component of a life support device or system whose failure to perform can be reasonably expected to cause the failure of the life support device or system, or to affect its safety or effectiveness.

PRODUCT STATUS DEFINITIONS

Definition of Terms

Datasheet Identification	Product Status	Definition
Advance Information	Formative or In Design	This datasheet contains the design specifications for product development. Specifications may change in any manner without notice.
Preliminary	First Production	This datasheet contains preliminary data, and supplementary data will be published at a later date. Fairchild Semiconductor reserves the right to make changes at any time without notice in order to improve design.
No Identification Needed	Full Production	This datasheet contains final specifications. Fairchild Semiconductor reserves the right to make changes at any time without notice in order to improve design.
Obsolete	Not In Production	This datasheet contains specifications on a product that has been discontinued by Fairchild semiconductor. The datasheet is printed for reference information only.